

izi Combi Isofix™

REARWARD- & FORWARD-FACING

USER MANUAL

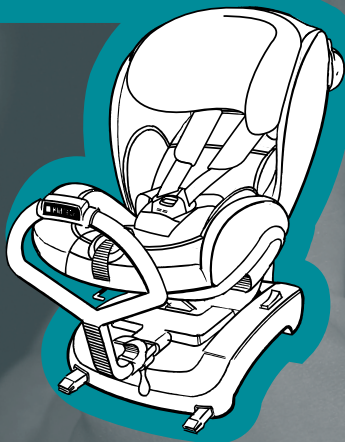

ECE R44 04

GROUP
0+/1

WEIGHT
0-18 kg

AGE
6m-4y



BeSafe®

Thank you for choosing BeSafe iZi Combi ISOfix.

BeSafe has developed this seat with much care, to protect your child during the next phase of her or his life.

! It is important that you read this user manual BEFORE installing your seat. Incorrect installation could endanger your child.

Contents

Vital information	3
Preparing to install	4
Rearward-facing ISOfix installation	5
Removing the seat	9
Forward-facing belt installation	10
Removing the seat	11
Positioning of the child	12
Sleeping position	13
Removing and refitting the cover	14
Cleaning instructions	16
Warning: potential misuse	16
Important advice	18
Point of sale information	19
Guarantee	20

Vital information



- It is NOT ALLOWED to mount the seat in a front passenger seat WITH AN ACTIVATED AIRBAG.
- iZi Combi ISOfix can be installed rearward-facing with the ISOfix anchorage in a car equipped with ISOfix anchorage points.
- iZi Combi ISOfix can be installed forward-facing with a 3-point car belt, approved to UN/ECE Regulation No. 16 or other equivalent standards.
- iZi Combi ISOfix is approved in groups 0+ and 1, rearward-facing from 0-18 kg and group 1, forward-facing from 9-18 kg.
- Read the car list to find out whether your car model is approved to use the seat.
- The harness straps must always be locked when the child is in the seat.
- The harness straps must be tightened without slack and not twisted.
- The seat cover contains magnets in the areas with the orange indications. Magnets can influence electronic equipment like pacemakers.
- The floor support must always be used when it is installed rearward-facing. Make sure that the floor support is fully pushed down. When installing forward-facing the floor support and the front brace shall not be used.
- When installed with ISOfix: Make sure the indicators are green before you drive.
- We recommend to use the seat as long as possible in the rearward-facing installation.
- We recommend that this seat is used only for children who can sit upright, so not younger than 6 months.
- For children under 1 year and/or under 10 kg weight, we recommend that the most reclined sitting position and the body hugger and seat cushion are used.
- When the child weighs over 18 kg or the shoulder height grows above the highest position of the shoulder straps, the child must change to a group 2/3 seat.
- After an accident, the seat must be replaced. Although it may look undamaged, if you were to have another accident, the seat may not be able to protect your child as well as it should.

Preparing to install

Crucial parts

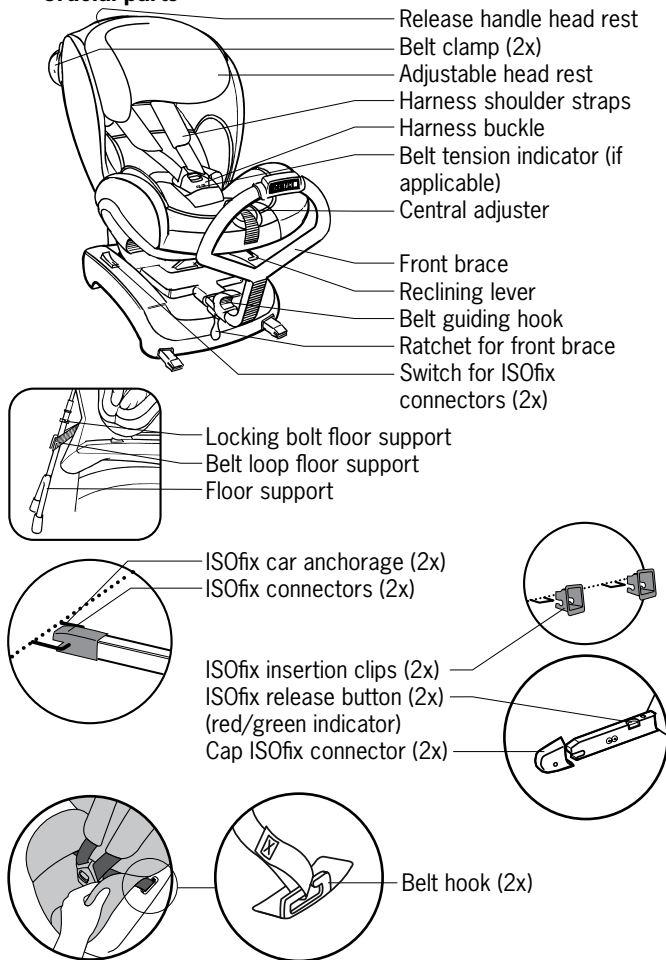

Rearward-facing: ISOfix installation

- It is **NOT ALLOWED** to mount the seat in a front passenger seat **WITH AN ACTIVATED AIRBAG**.
- The seat can only be installed rearward-facing in vehicles equipped with ISOfix anchorage points.



- 1- When mounting in the back seat of the vehicle, push the front seat of the vehicle forward as much as possible. When mounting in the front seat of the vehicle, adjust the back rest in an upright position.

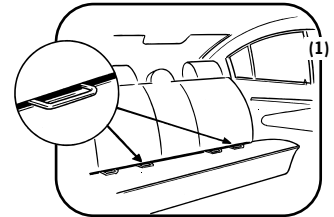

- 2- Find the ISOfix anchorage points in the vehicle (1).

- 3- If your vehicle is not equipped with ISOfix insertion clips insert these to make installation easier. You can find the ISOfix insertion clips under the base of the seat or delivered separately with the seat (2).

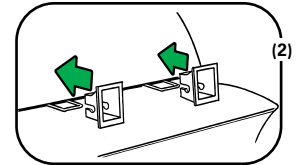

- 4- Remove the caps from the ISOfix connectors by pressing down the ISOfix release buttons (3).

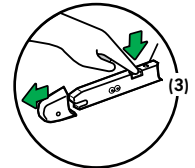

- 5- Install the front brace by sliding the two pins in the holes of the belt guiding hook. Move the front brace inwards with the ratchet, not further than the stop sign. The ratchet is used to adjust the front brace in both directions. Slide the knobs (see red circle) on the ratchet up or down to change direction (4).

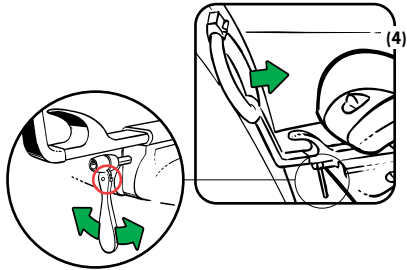

- 6- Assemble the floor support before you install the seat in your vehicle.
7- The floor support must go through the belt loop. The belt loop must also be led into the hook on the floor support (5).
8- Do not fasten the locking bolt yet.

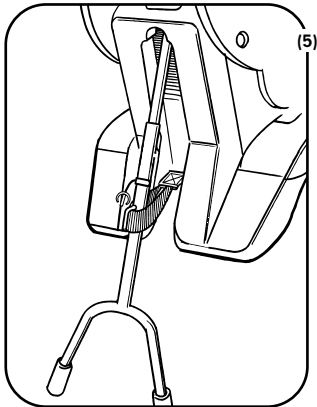

- 9- Place the seat sideways into the car with the front brace towards you.
10- Turn the seat into the right position (with the front brace against the back rest).
11- Push the floor support down to the floor.
12- Pull both ISOfix connectors as far out as possible (6). The switch will go into the lowest position and locks the ISOfix connectors.

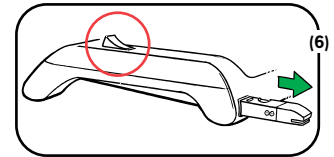

- 13- Click the ISOfix connectors in the ISOfix anchorage of the vehicle (7). Make sure that both indicators are green (8).

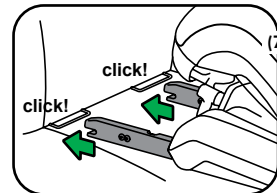

- 14- Adjust the floor support so it is in contact with the floor of the vehicle (9).

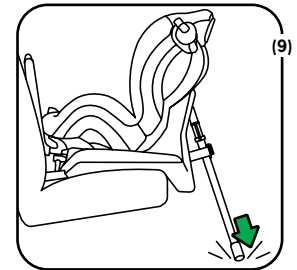

- 15- Move the front brace outwards with the ratchet. Continue tightening until the brace is pressed well into the back rest of the vehicle seat (10).

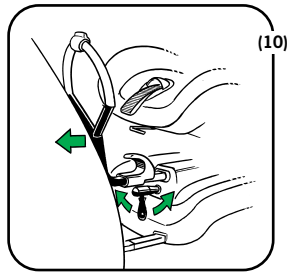

- 16- Lock the floor support with the locking bolt (11).

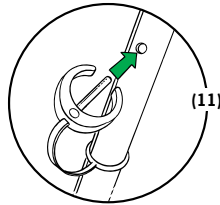

- 17- Positioned in the back seat of the vehicle, you should, if possible, push the front seat of the vehicle backwards, so that it is in contact with the child seat. If it is not possible to obtain contact with the child seat, push the back rest of the front seat of the vehicle forward so that the distance between child seat and back rest of the front seat of the vehicle is minimum 25 cm. Positioned in the front seat of the vehicle, you should position the seat against the dashboard.

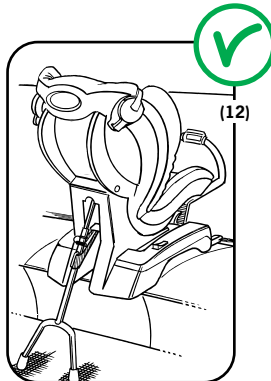

- Make sure the floor support is fully pushed down, in contact with the floor of the vehicle, and locked. !
- Make sure all ISOfix indicators are green before you drive.

Removing the seat

- 1- If the seat is installed in the back seat of the vehicle, push the front seat of the vehicle forward as much as possible
- 2- Move the front brace inwards with the ratchet, not further than the stop sign.
- 3- Remove the locking bolt from the floor support, adjust the floor support in the highest position and lock again with the locking bolt.
- 4- Release the ISOfix connectors by pressing the release mechanism on the ISOfix connectors. The indicators will show red when the ISOfix connectors are released (13).
- 5- Push the switch on each side and push the ISOfix connectors into the base (14).
- 6- Pull the seat back towards the front. Turn the seat so you can easily remove the seat.
- 7- Remove the insertion clips from the vehicle. Place them under the base of the child seat.

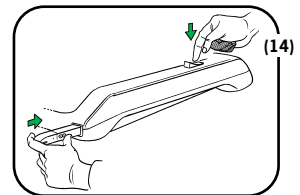
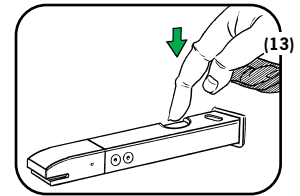



Forward-facing belt installation

!

It is NOT ALLOWED to mount the seat in a front passenger seat WITH AN ACTIVATED AIRBAG.



- 1- When mounting in the back seat of the vehicle, push the front seat of the vehicle forward as much as possible.
When mounting in the front seat of the vehicle, adjust the back rest in an upright position.

- 2- Remove the floor support and the front brace from the seat.

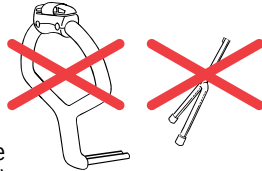

- 3- Put the child seat on the seat of the vehicle. Unlock the belt clamps (15).

- 4- Release the release handle at the back of the head rest and push the head rest down while keeping the head rest upright (16).

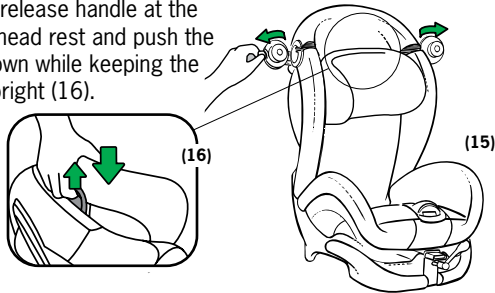

- 5- Pull the hip belt around the bottom base of the seat and click the car belt in the buckle (17).

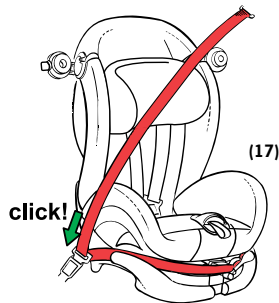

- 6- Position the hip belt over the belt guiding hook (17).

- 7- Put the shoulder belt through the belt clamps. Make sure the belt is not twisted (18).

- 8- Push the seat firmly into the car seat.

- 9- Tight installation is most important for forward facing seats.

Tension the belts as follows: Pull the shoulder belt upwards (A). Have a firm grip on the shoulder belt in the seat area (B). Close the clamp on the inner side (C). Pull upper belt part on the door side and close clamp D (18).

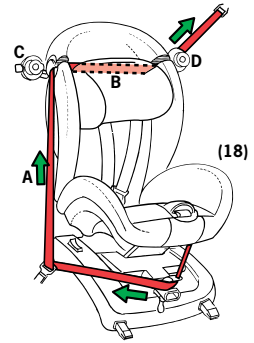

- 10- Adjust the belt guiding hook outwards with the ratchet (19). Continue tightening until the seat is pressed well into the back rest of the car seat. Push the head rest in the correct position (refer to 'Positioning of the child' on page 12). The seat is now ready to use.

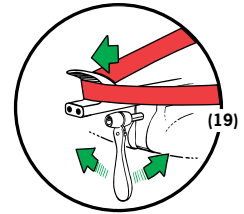

Removing the seat

- 1- Loosen the tension in the car belt by moving the belt guiding hook inwards with the ratchet, not further than the stop sign.
- 2- If the seat is installed in the back seat of the vehicle, push the front seat of the vehicle forward as much as possible.
- 3- Unlock the belt clamps and unlock the car belt.
- 4- Remove the car belt and remove the seat from the vehicle.

Positioning of the child

1- Position of the shoulder straps:
Check that the shoulder strap slots are levelled with your child's shoulders (20).

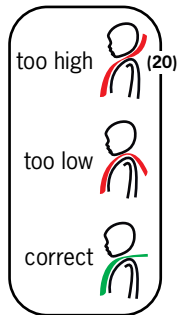

2- The height of the shoulder straps and the head rest can be adjusted by releasing the release handle at the back of the head rest and pulling the head rest up or down while keeping the head rest upright (21).

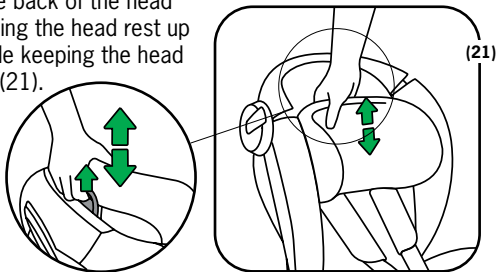

3- Pull the shoulder straps up while pressing the button of the central adjuster (22).

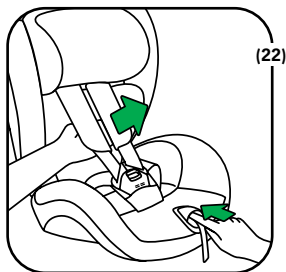

4- Open the harness buckle.

5- Position the shoulder straps over the orange marking at sides of the seat to keep the harness open while you position the child (23).

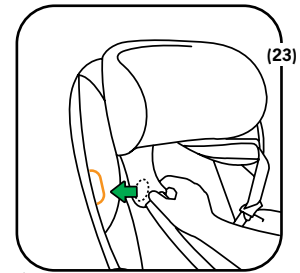

6- When the child is positioned, place the shoulder straps over the child's shoulders and close the buckle: CLICK! (24).

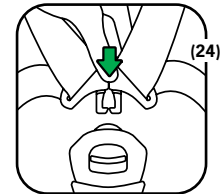

7- Pull the harness strap through the central adjuster in the direction of the green arrow straight up-/forwards. Continue pulling until the harness is a comfortable but firm fit. The belt tension indicator will show green (25).

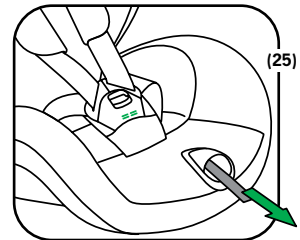

Make sure that the harness straps are always locked and tightened when the child is in the seat. !

Sleeping position

- The seat has 4 reclining positions
- By pulling the reclining lever upwards, the seat can be put in another position (26).

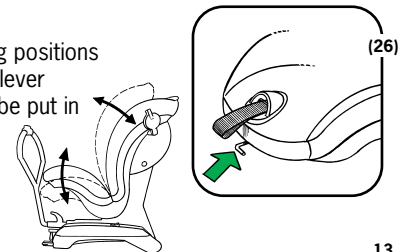

Removing and refitting the cover

- ! • Make sure that the harness straps are fixed in the right way, after fitting the cover.

Removing the cover

- 1- Pay attention when you remove the cover, as fitting the cover is done in the opposite way.
- 2- To remove the seat cover, the harness straps must be released at both sides. See red circle (27).

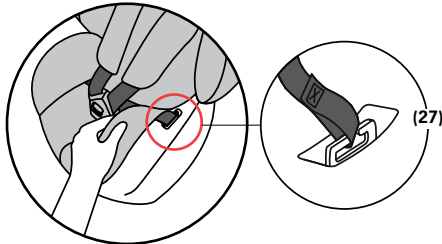

- 3- Start to take off the lower seat part and unhook both harness straps from the metal belt hooks.
- 4- The cover of the head rest can be taken off separately by disconnecting the hooks at the backside and pulling off the fabric to the front.

Refit the cover

- 1- Pull the head rest in the highest position. Mount the head rest cover and connect the hooks at the back side. Pull the harness straps through the holes. Connect the loose bottom part of the head rest fabric with the plastic part under the head rest.
- 2- Pull the harness straps through the opening of the seat cover and lock the harness buckle. Pull the crotch strap through the opening of the seat part.
- 3- Pull the loops of the harness straps from the bottom of the seat part through the openings to the hooks in the bottom of the seat. Hook both harness straps on the metal belt hooks and pull the straps firmly to ensure that they are correctly installed (28).

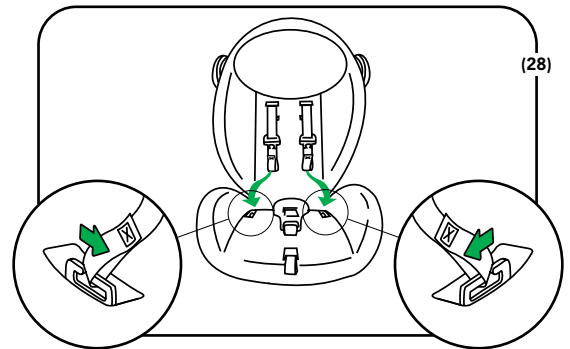

- 4- Mount the top part and then the shoulder parts. Mount the seat part and bring the seat cover under the rear parts of the sidewalls.

Cleaning instructions

- The cover of the seat must be washed according to the instructions on the inside of the cover (29).

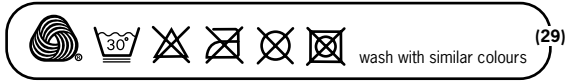

- DO NOT use any aggressive cleaning products; these may harm the construction material of the seat.

Warning: potential misuse

- It is NOT ALLOWED to mount the seat in a front passenger seat WITH AN ACTIVATED AIRBAG.
- Install only with 3-point car belts, approved to UN/ECE Regulation No. 16 or other equivalent standards (30).



(30)

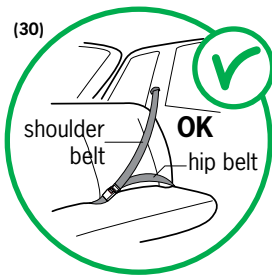

- DO NOT use the seat without floor support when mounted rearward-facing. !



- DO NOT use the seat without tightening the front brace when mounted rearward-facing. !



- DO NOT drive with RED ISOfix indicators. !

Important advice

- DO NOT attempt to dismantle, modify or add any part to the seat. Warranty will expire if non-original parts or accessories are used.
- DO NOT use anything, such as a cushion, to raise the child seat off the passenger seat of the vehicle. In an accident the seat will not be able to protect your child in the right way.
- Never leave your child unattended in the seat.
- Make sure all passengers are informed about how to release your child in case of emergency.
- An unoccupied child seat should always be fastened in the vehicle.
- Make sure luggage or other objects are properly secured. Unsecured luggage may cause severe injuries to children and adults in case of accidents.
- Never use the seat without the cover. The cover is a safety feature and may only be replaced by an original BeSafe cover.
- Under the fabric cover we use EPS foam. Do not push or pull too hard against the foam, since you might damage the foam.
- Do not use any aggressive cleaning products; these may harm the construction material of the seat.
- BeSafe advises that child seats should not be bought or sold second-hand.
- KEEP this user manual for later use with the seat.
- DO NOT use the seat for longer than 5 years. Due to ageing, the quality of the material may change.
- DO NOT use at home. It has not been designed for home use and can only be used in a vehicle.
- When installed with ISOfix: Check the manufacturer's vehicle handbook.

Practical advice

When the child seat is mounted in the car check all the areas where the child seat might touch the interior. We recommend using a (BeSafe) protection cover in these places to avoid cuts, marks or discolouration on the interior of the vehicle, especially in vehicles with leather or wooden interior.

Point of sale information

Notice for REARWARD-FACING installation

- This is a semi-universal ISOfix Child Restraint System. It is approved to regulation No. 44.04, series of amendments for general use in vehicles fitted with ISOfix anchorage systems.
- It will fit cars with positions approved as ISOfix positions (as detailed in the vehicle handbook), depending on category of the child seat and of the fixture.
- The mass group and the ISOfix size class for which this device is intended is: C.
- The seat is suitable for fixing into the seat positions of the vehicles listed in the separate 'car list'. Seat positions in other vehicles may also be suitable to accept this child restraint. If in doubt, consult either the child restraint manufacturer or the retailer. For updated car list see: www.besafe.eu

Notice for FORWARD-FACING installation

- When installed with a 3-point car belt: Only suitable if the approved vehicles are fitted with 3-point car belts, approved to UN/ECE Regulation No. 16 or other equivalent standards.
- We recommend to use the seat as long as possible in the rearward-facing installation.

Next car seat

- The BeSafe iZi Up is a group 2/3 seat which can be used for children from 15 till 36 kg, which covers the age group from 4 till 12 years.

Guarantee

- All BeSafe products are carefully designed, manufactured and tested. All of our BeSafe child seats are tested periodically out of our continuous production in our test laboratory. Furthermore they are tested by independent test institutes.
- Should this product prove faulty within 24 months of purchase due to materials or manufacturing fault, except covers and harness straps, please return it to the original place of purchase.
- The guarantee is only valid when you use your seat appropriately and with care. Please contact your dealer, he will decide if the seat will be returned to the manufacturer for repair. Replacement or return cannot be claimed. The guarantee does not get extended through repair.
- The guarantee expires: when there is no receipt, when defects are caused by wrong and improper use, when defects are caused by abuse, misuse or negligence.

semi-universal
0-18 kg



R 44 04201

universal
9-18 kg



R44 04202

HTS BeSafe as
N-3535 Krøderen, Norway - www.besafe.eu

BeSafe®